

# THT/WALL-F

**Dynamic wall mounted extractor fans with motorised hatch, for smoke exhaust in case of fires, 400 °C/2h and 300 °C/2h**



Dynamic wall extractor fans with motorised opening system and protective grating for use without extract duct. Specially designed for the fast, effective exhaust of harmful smoke and gases in the event of fire. Suitable for installation in industrial buildings, stores or in any other type of building. Can be used for ambient ventilation.

**Fan:**

- Wall fixing flange for correct and easy installation.
- Support frame in galvanised sheet steel.
- Approved in accordance with standard EN 12101-3, with certifications no.: 0370-CPR-0305 (F400) and 0370-CPR-0973 (F300).
- Variable angle impeller made of cast aluminium.
- Shielded power cable with EMC protection.
- Airflow direction from motor to impeller.
- Protection grid against contacts according to UNE-EN ISO 12499.

**Extruded aluminum hatch:**

- An extremely robust structure that is able to withstand severe weather changes.
- Designed to ensure watertightness.
- Aluminum profile with thermal bridge break.
- Central ceiling and structure equipped with high performance thermal insulation.
- Thermal resistance of the assembly less than 0.89 W/m<sup>2</sup>·K.
- Position indicators in both positions (open and closed).

- Upper and lower opening mounting versions.
- Manual opening system.
- Airborne acoustic insulation value according to UNE-EN ISO 10140-2:  $R_w = 27 (0; -2)$  dB.

**Motor:**

- Class H motors for S1 continuous operation and S2 emergency use. With ball bearings, IP55 protection and 1 or 2 speeds, depending on model.
- IE3 efficiency motors.
- Three-phase 230/400 V 50 Hz (up to 3 kW) and 400/690 V 50 Hz (powers greater than 3 kW).
- Maximum temperature of air to be carried: S1 -25 °C +40 °C continuous service, also suitable for warm climates with temperatures up to 50 °C. S2 operation, 300 °C/2h, 400 °C/2h.

**Actuator:**

- Reliability greater than 20,000 dual cycles.
- Supply voltage at 230 V AC 50/60 Hz.
- Working temperature: -25 °C +60 °C.
- Protection at the leading edge when closing the hatch.
- The stop in the closed position is regulated by an electronic limit switch.

**Hatch finish:**

- Anti-corrosive in extruded aluminum.
- RAL 7016 supplied as standard. Any other RAL can be supplied on demand.

**On request:**

- Actuator with 24 V DC supply voltage.

## Order code

From size 40 to size 56

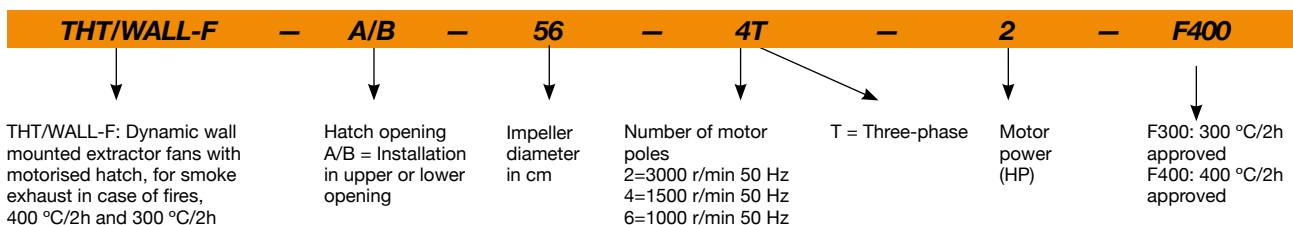

From size 63 to size 100

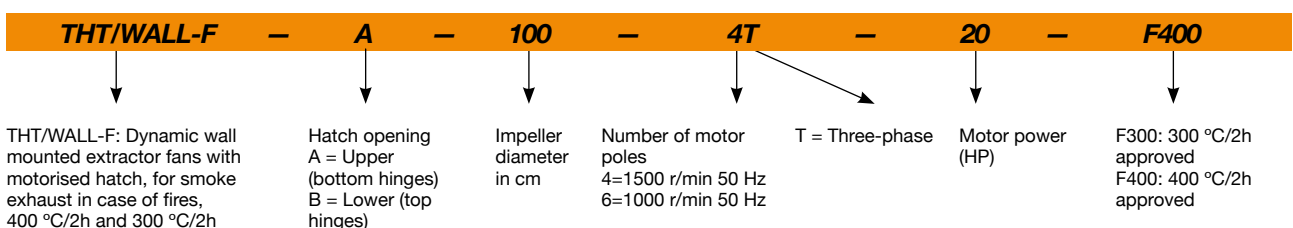

## Technical characteristics

Model	Speed (r/min)	Maximum admissible current (A)			Installed power (kW)	Blade tilt angle (°)	Maximum flow rate (m³/h)	Sound pressure level <sup>1</sup> dB (A)		Approx. weight (Kg)
		230V	400V	690V				Inlet	Exhaust	
THT/WALL-F-40-2T-1.5 IE3	2880	3.93	2.26		1.10	20	7040	61	61	55
THT/WALL-F-45-2T-2 IE3	2880	4.91	2.84		1.50	16	9400	61	61	63
THT/WALL-F-45-2T-3 IE3	2840	7.14	4.13		2.20	22	11325	61	61	67
THT/WALL-F-56-4T-2 IE3	1440	5.89	3.38		1.50	36	15020	54	54	69
THT/WALL-F-63-4T-3 IE3	1425	7.86	4.52		2.20	32	22170	58	58	97
THT/WALL-F-63-4T-4 IE3	1430	11.01	6.33		3.00	38	24240	59	59	103
THT/WALL-F-71-4T-3 IE3	1425	7.86	4.52		2.20	22	25100	60	60	100
THT/WALL-F-71-4T-4 IE3	1430	11.01	6.33		3.00	28	27480	60	60	106
THT/WALL-F-71-6T-1.5 IE3	945	4.73	2.72		1.10	34	19930	51	51	98
THT/WALL-F-80-4T-3 IE3	1425	7.86	4.52		2.20	12	25460	65	65	114
THT/WALL-F-80-4T-4 IE3	1430	11.01	6.33		3.00	16	30270	64	64	120
THT/WALL-F-80-4T-5.5 IE3	1440		7.95	4.61	4.00	18	32770	63	63	122
THT/WALL-F-80-4T-7.5 IE3	1460		10.4	6.04	5.50	26	39640	63	63	152
THT/WALL-F-80-6T-1.5 IE3	945	4.73	2.72		1.10	18	21470	53	53	112
THT/WALL-F-80-6T-2 IE3	945	6.25	3.62		1.50	26	25970	54	54	116
THT/WALL-F-90-4T-7.5 IE3	1460		10.4	6.04	5.50	18	46140	67	67	183
THT/WALL-F-90-4T-10 IE3	1460		14.2	8.17	7.50	22	50140	66	66	187
THT/WALL-F-90-6T-3 IE3	950	9.78	5.62		2.20	24	34000	56	56	145
THT/WALL-F-90-6T-4 IE3	970	12.8	6.36		3.00	30	38910	59	59	165
THT/WALL-F-100-4T-10 IE3	1460		14.2	8.17	7.50	16	57420	69	69	194
THT/WALL-F-100-4T-15 IE3	1460		20.7	11.99	11.00	22	66300	69	69	226
THT/WALL-F-100-4T-20 IE3	1460		27.8	16.03	15.00	28	76160	70	70	237
THT/WALL-F-100-6T-5.5 IE3	970		8.37	4.82	4.00	26	47780	60	60	178

<sup>1</sup> The noise level values are pressures in dB(A) measured at a distance of 10 metres in a free field.

## Technical characteristics of the dynamic exhaust system based on standard EN 12101-3

Model	Approval (°C)	Motor insulation class	Durability	Temperature room temperature (°C)	Wind load (Pa)
THT/WALL-F	F300 and F400	Class H	RE >20000	-25	WL 200

## Acoustic characteristics

The values given are obtained under laboratory conditions according to ISO 3744.  
Sound power spectrum Lw(A) in dB(A) per Hz frequency band

Values measured at inlet with maximum flow rate

	63	125	250	500	1000	2000	4000	8000
40-2-1.5	47	63	75	83	88	86	82	75
45-2-2	47	60	74	86	87	86	82	74
45-2-3	47	64	74	81	88	86	83	75
56-4-2	52	64	73	79	79	79	73	65
63-4-3	56	68	77	83	83	83	77	69
63-4-4	57	69	78	84	84	84	78	70
71-4-3	56	72	79	85	85	85	81	73
71-4-4	63	75	79	85	85	86	83	75
71-6-1.5	47	65	74	77	77	72	65	56
80-4-3	55	71	84	91	91	88	82	74
80-4-4	54	70	83	90	90	87	81	73
80-4-5.5	53	69	82	89	89	86	80	72
80-4-7.5	53	69	82	89	89	86	80	72
80-6-1.5	53	68	75	78	79	76	70	62
80-6-2	59	69	75	79	80	78	73	65
90-4-7.5	59	75	86	92	93	91	86	78
90-4-10	58	74	85	91	92	90	85	77
90-6-3	52	67	78	82	82	78	71	63
90-6-4	60	70	80	85	85	82	76	68
100-4-10	64	80	87	94	95	93	89	81
100-4-15	71	83	87	93	94	94	91	83
100-4-20	72	84	88	94	95	95	92	84
100-6-5.5	57	72	82	85	86	83	75	67

Values measured at exhaust with maximum flow rate

	63	125	250	500	1000	2000	4000	8000
40-2-1.5	47	63	75	83	88	86	82	75
45-2-2	47	60	74	86	87	86	82	74
45-2-3	47	64	74	81	88	86	83	75
56-4-2	52	64	73	79	79	79	73	65
63-4-3	56	68	77	83	83	83	77	69
63-4-4	57	69	78	84	84	84	78	70
71-4-3	56	72	79	85	85	85	81	73
71-4-4	63	75	79	85	85	86	83	75
71-6-1.5	47	65	74	77	77	72	65	56
80-4-3	55	71	84	91	91	88	82	74
80-4-4	54	70	83	90	90	87	81	73
80-4-5.5	53	69	82	89	89	86	80	72
80-4-7.5	53	69	82	89	89	86	80	72
80-6-1.5	53	68	75	78	79	76	70	62
80-6-2	59	69	75	79	80	78	73	65
90-4-7.5	59	75	86	92	93	91	86	78
90-4-10	58	74	85	91	92	90	85	77
90-6-3	52	67	78	82	82	78	71	63
90-6-4	60	70	80	85	85	82	76	68
100-4-10	64	80	87	94	95	93	89	81
100-4-15	71	83	87	93	94	94	91	83
100-4-20	72	84	88	94	95	95	92	84
100-6-5.5	57	72	82	85	86	83	75	67

**Dimensions mm**

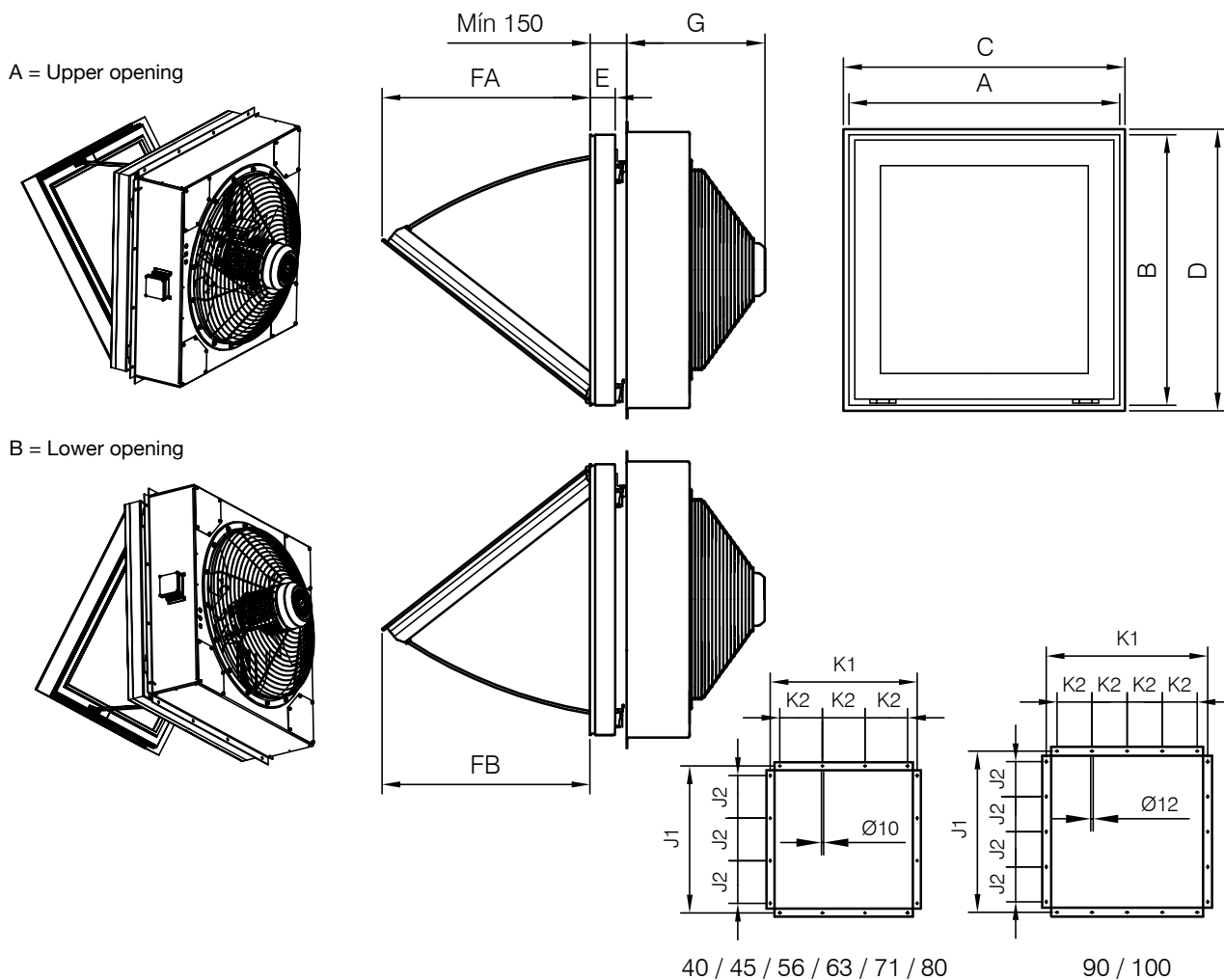

	A	B	C	D	E	FA	FB	G	J1	J2	K1	K2
THT/WALL-F-40	640	590	650	600	82	460	460	375	740	200	740	200
THT/WALL-F-45	640	590	650	600	82	460	460	400	740	200	740	200
THT/WALL-F-56	690	690	700	700	82	551	551	415	830	220	830	220
THT/WALL-F-63	990	990	1000	1000	82	875	875	475	1090	300	1090	300
THT/WALL-F-71	990	990	1000	1000	82	875	875	500	1090	300	1090	300
THT/WALL-F-80	990	990	1000	1000	82	875	875	500	1090	300	1090	300
THT/WALL-F-90	1190	1190	1200	1200	82	922	922	525	1310	250	1310	250
THT/WALL-F-100	1190	1190	1200	1200	82	922	922	550	1310	250	1310	250

(C x D) Nominal size of the wall opening.  
 FA is the opening when the hatch is upper opening.  
 FB is the opening when the hatch is lower opening.

## Characteristic curves

Q= Flow rate in m<sup>3</sup>/h, m<sup>3</sup>/s and cfm

Pe= Static pressure in mm H<sub>2</sub>O, Pa and inWG

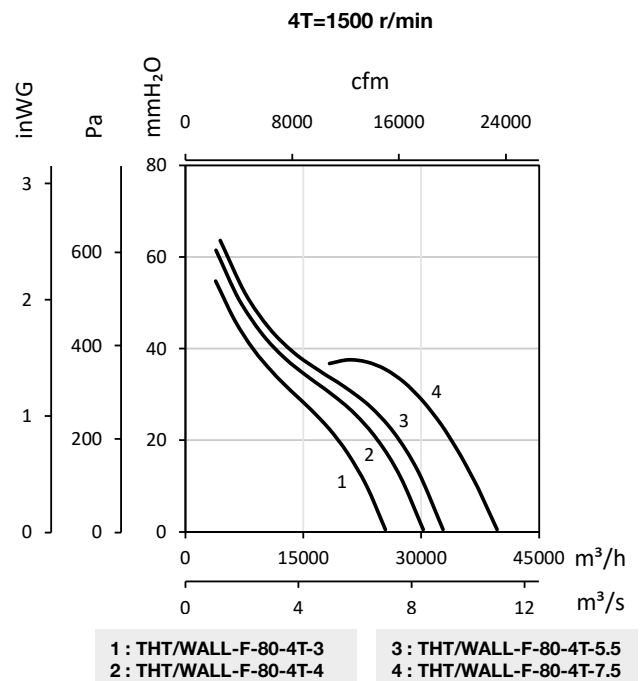
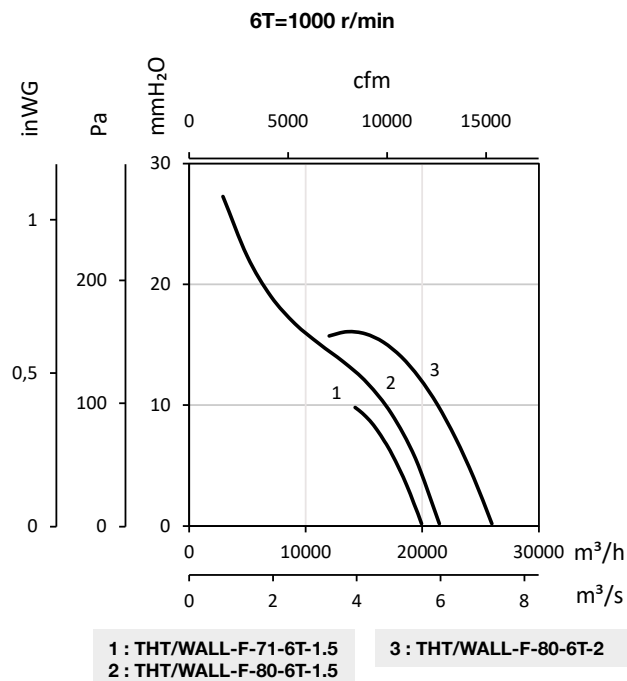
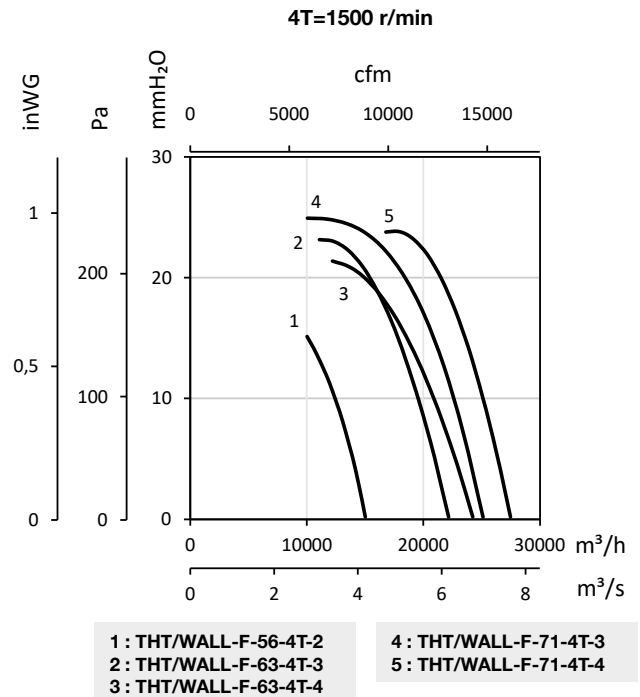
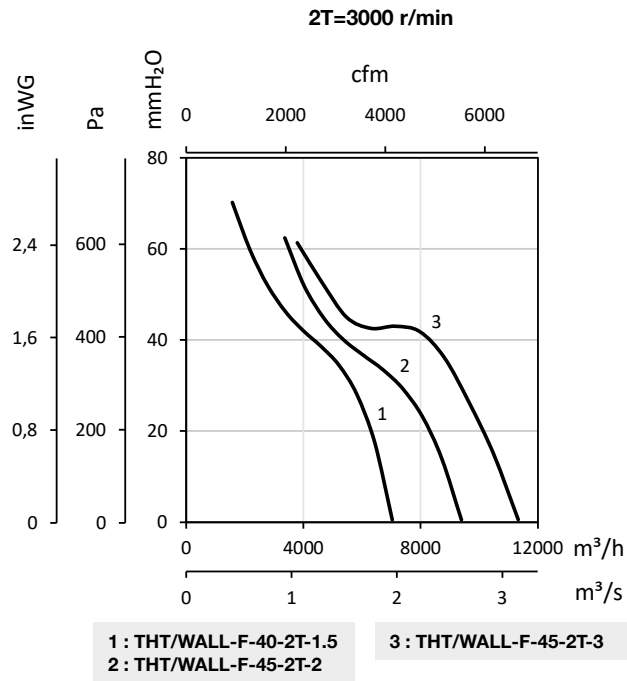

## Characteristic curves

Q= Flow rate in m<sup>3</sup>/h, m<sup>3</sup>/s and cfm

Pe= Static pressure in mm H<sub>2</sub>O, Pa and inwg

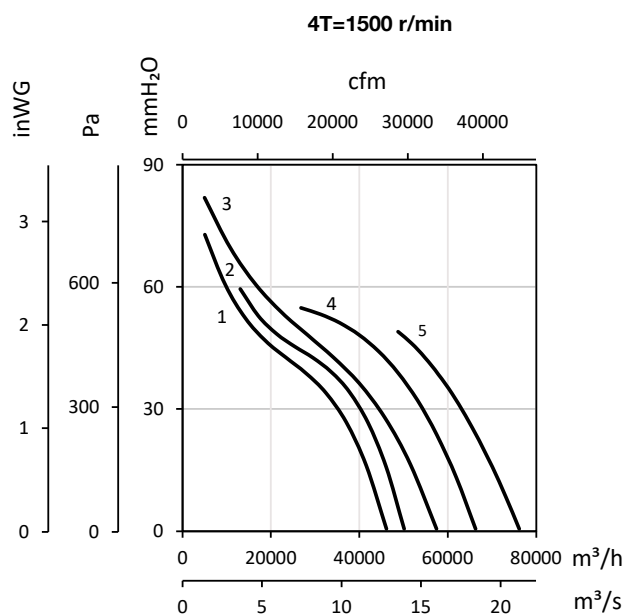

1 : THT/WALL-F-90-4T-7.5  
2 : THT/WALL-F-90-4T-10  
3 : THT/WALL-F-100-4T-10

4 : THT/WALL-F-100-4T-15  
5 : THT/WALL-F-100-4T-20

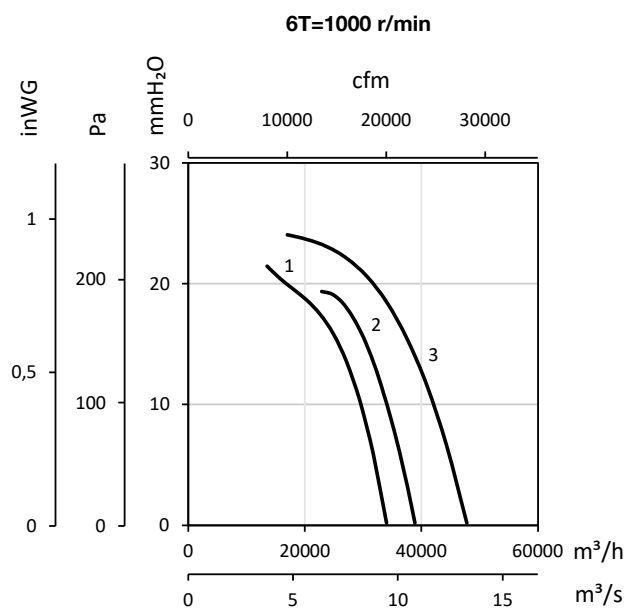

1 : THT/WALL-F-90-6T-3  
2 : THT/WALL-F-90-6T-4

3 : THT/WALL-F-100-6T-5.5

## Accessories

